



FASTRAC | 8000 SERIES

Rated power: 209-250kW (280-335hp) Rear lift capacity: 10 tonnes





Discover the difference

Just one look tells you the Fastrac 8000 is different. Discover how greater speed, comfort, productivity, safety and versatility can make the difference to you and your business.

The Fastrac 8000 is the largest and most powerful JCB tractor yet. It is faster, more comfortable, more versatile and has more safety features than any other tractor in its class, letting you get even more done in a day.





SPEED WITH SAFETY.

THE FASTEST PRODUCTION TRACTOR IN THE WORLD WITH A TOP SPEED OF 70KPH AND MORE SAFETY FEATURES THAN ANY OTHER TRACTOR. THAT'S THE BIG FASTRAC DIFFERENCE.

No compromise on machine control.

1 A unique Fastrac feature - external brakes on both axles and powerful twin calipers with air-over hydraulic operation to meet EU truck standards to stop consistently up to 15% quicker than conventional tractors.

2 Advanced anti-lock system (ABS) retains stability and steering while optimising braking performance - on the road, along farm tracks and in the field. A trailer ABS connection is standard too.

The Fastrac's fail-safe set-up ensures the brakes are applied in the event of a loss of pressure. A transmission disc park brake holds the tractor securely and applies air brakes on a trailer, tanker or spreader too.

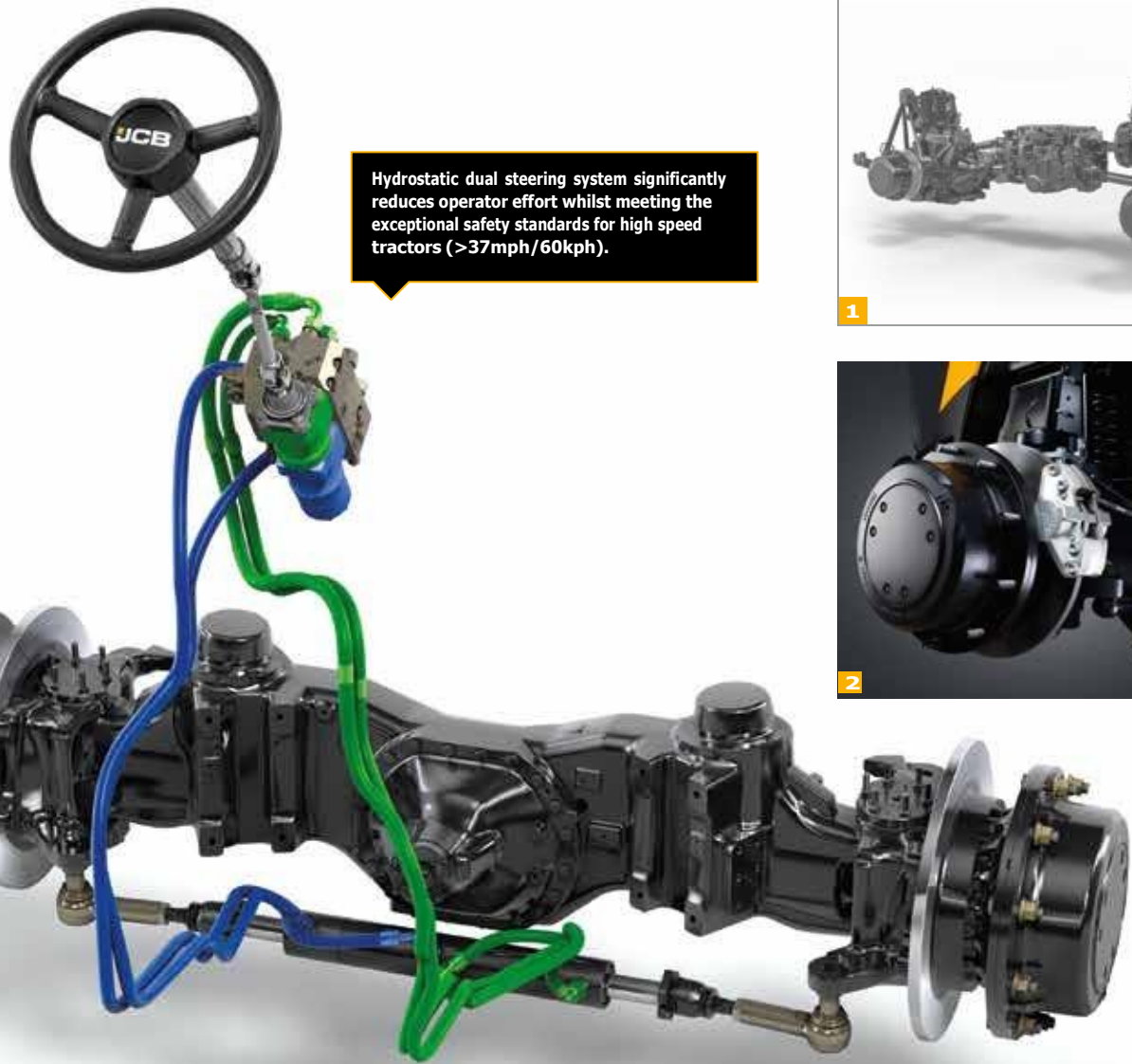

Hydrostatic dual steering system significantly reduces operator effort whilst meeting the exceptional safety standards for high speed tractors (>37mph/60kph).

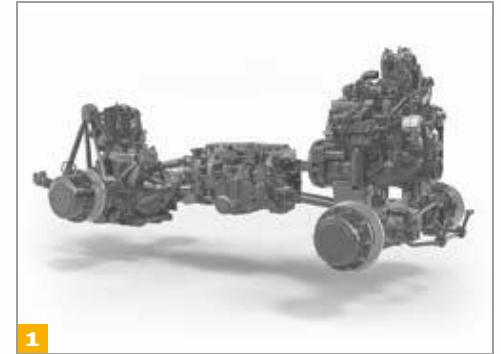



On the road, the steering is precise and well weighted, which provides ultimate control when travelling at 70kph.

Add the Rapid Steer option to reduce lock to lock turn of the steering wheel by 50% and make headland and other field manoeuvres quicker and easier.

Optional road performance package incorporates traction control and hill hold feature, unique to JCB.

ULTIMATE COMFORT.

THE 8000 SERIES FASTRAC COMBINES A UNIQUE SUSPENSION SYSTEM WITH THE COMMANDPLUS CAB TO GIVE CLASS LEADING LEVELS OF COMFORT FOR THE OPERATOR.

Driving is believing.

1 All round advanced hydropneumatic suspension provides unrivalled comfort & stability - unique to JCB Fastrac.

2 Mid-mounted cab position gives additional comfort and excellent 360 visibility.

There is no obstruction of visibility by the exhaust stack.

3 Forward-raked 'A' pillars make the doorways bigger and increase interior spaciousness, while the near-vertical windscreen reduces heat absorption on a sunny day.

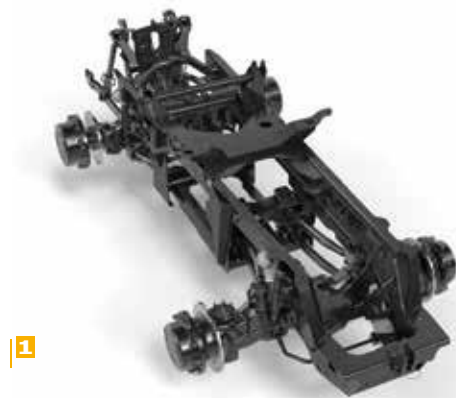

1



2



3



Advanced suspension quickly responds to changing loads applied by front and rear mounted implements to help distribute the load evenly across the machine.

GREATER PRODUCTIVITY.

WITH FASTER ROAD AND IN-FIELD SPEEDS PLUS UNIQUE ALL-ROUND SUSPENSION, THE FASTRAC 8000 SERIES IS A GREAT BUSINESS SOLUTION.

It's a brilliant draft work tractor...

1 With near 50:50 weight distribution, a wide range of tyre brands and widths available and the traction advantages of suspension on both axles, the 8000 series Fastrac is ideally equipped for heavy draft work.

...and brilliant with trailed equipment too!

2 Legally equipped for its 43mph (70kph) top speed with all-round suspension and truck standard air braking, the Fastrac moves from job to job quicker and more safely than any other tractor of its size and power.

3 No holding back - a rough field surface is no deterrent to Fastrac operators with all round suspension and a high-spec air seat smoothing the way for baling, spreading and spraying operations. Operators can be more productive for more hours of the day.





Powerful hydraulics meet the demand of implements through 6 double acting electric spool valves and "power beyond". 140 litres/min per valve slice using an oil supply that is separate from the transmission to prevent contamination.

BEST-IN-CLASS VERSATILITY.

A PURPOSE-DESIGNED CHASSIS MAKES THE DIFFERENCE WHEN IT COMES TO GREATER IMPLEMENT MOUNTING VERSATILITY. SO WHEREVER YOU ARE IN THE WORLD, WHATEVER YOUR APPLICATION, THE FASTRAC DELIVERS.



Handles with care.

1 The Fastrac's powerful Category III rear hitch lifts a genuine 10,000kg to handle large ploughs, cultivators and mounted drills. Sensitive electronic draft control helps maintain traction under heavy load.

2 For added productivity, use the optional Category 3N front hitch with 3500kg capacity, external lift/lower control and optional power & lighting sockets.

3 Rear deck mounted 900kg or 1,600kg ballast weights provide additional traction. This load is suspended, providing additional comfort over wheel weight systems.

The rear deck weights are also quick and easy to fit/remove, encouraging correct and efficient use of ballast.



Heavy-duty axles can be used at 3m track width for controlled traffic and row crop applications.



ALL THE POWER YOU NEED.

THE BEST POWERTRAIN AND SUSPENSION SYSTEM COMBINE TO DELIVER THE ULTIMATE IN POWER, TORQUE AND TRACTION TO REALLY MAKE THE DIFFERENCE IN ANY SITUATION.

Efficient power delivery.

1 Highly efficient SCR and DOC emissions control combines with DPF technology meets Euro Stage V emissions standards.

Emissions control equipment is installed without impeding superb all-round visibility from the CommandPlus cab.

Unique Powershift mode has 15 speeds for field work, 10 for road use - an ideal option for less experienced operators.

Highly efficient two speed rear PTO (540E/1000rpm) and the optional front PTO (1000rpm) provide mechanical drive for both front and rear implements.

Drive on the accelerator pedal or use the joystick controller; engage cruise control or change speed on the fly - whichever best suits the situation and the driver's preference.

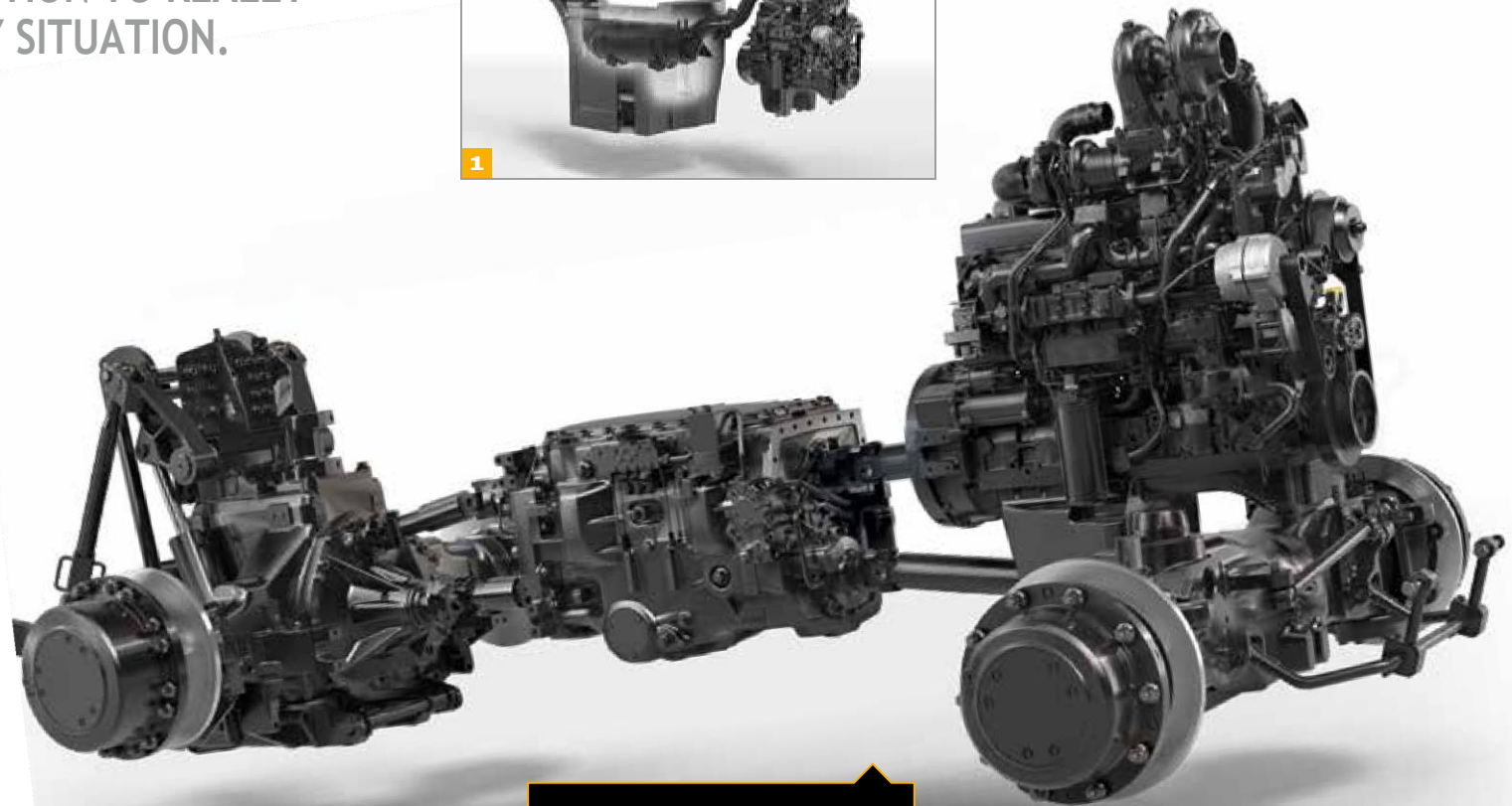

CVT transmission with improved cruise control functions ensures optimum use of power and torque.

Performance-proven 8.4-litre, six-cylinder engine delivers up to 335hp with twin turbocharger installation giving sharp responses and high torque ratings across a wide range of engine speeds.



TOTAL CONTROL.

IN CAB TECHNOLOGY THAT DELIVERS HIGH LEVELS OF TRACTOR AND IMPLEMENT CONTROL THROUGH A SIMPLE, EASY TO USE INTERFACE.

A touch easier.

Large icons on the Fastrac touch screen terminal are easier to finger-tap on the move; intuitive navigation gets quickly to the functions the operator wants to set or adjust.

Create and save up to 5 sequences each with up to 15 steps in the Headland Turn Assist section to minimise control workload at the end of each run across a field.

4 configurable joystick buttons can be assigned a wide range of functionality.





Factory fit GPS solutions available as well as compatibility with a wide range of 3rd party systems. For spraying and spreading applications, the Fastrac minimises overlap at speeds of up to 25mph (40kph).

DESIGNED TO PASS ANY TEST.

HOT WEATHER, COLD WEATHER, RAIN, SNOW, FOG, DUST AND MUD. THE FASTRAC 8000 SERIES HAS BEEN TESTED TO WORK IN EVERY CONDITION. SO WHEREVER AND WHENEVER YOU WORK, YOU WON'T NOTICE A DIFFERENCE IN PERFORMANCE.



Tried, tested, trusted.

1 Tested both in the field and on test rigs to ensure the Fastrac can pass any test.

2 Every nut and bolt, every moulding and fabrication, every sub-assembly and major component must work to the standard expected of every JCB machine.

Durability is designed-in and built-in; we change, improve and refine in response to customer feedback and to meet the high standards we set ourselves - and those of our customers.





From the fields of Southern Europe to the snowy landscapes of Scandinavia; we test our Fastrac tractors to the extreme.

MAXIMUM UPTIME.

WHEN IT COMES TO ROUTINE SERVICING AND MAINTENANCE YOU'LL EVEN NOTICE THE DIFFERENCE HERE. QUICK AND EASY ACCESS MEANS REDUCED DOWNTIME FOR THE FASTRAC 8000 SERIES.



Designed with care.

1 Dip the oil without lifting the bonnet, top up fuel, DEF (AdBlue) and oil for the hydraulics with ease as the fillers are all on the same side.

2 Reaching the batteries, battery isolator and brake fluid reservoirs could not be easier - just open a panel behind the right-hand cab steps.

3 External disc brake assemblies provide exceptional service access reducing service and maintenance downtime.



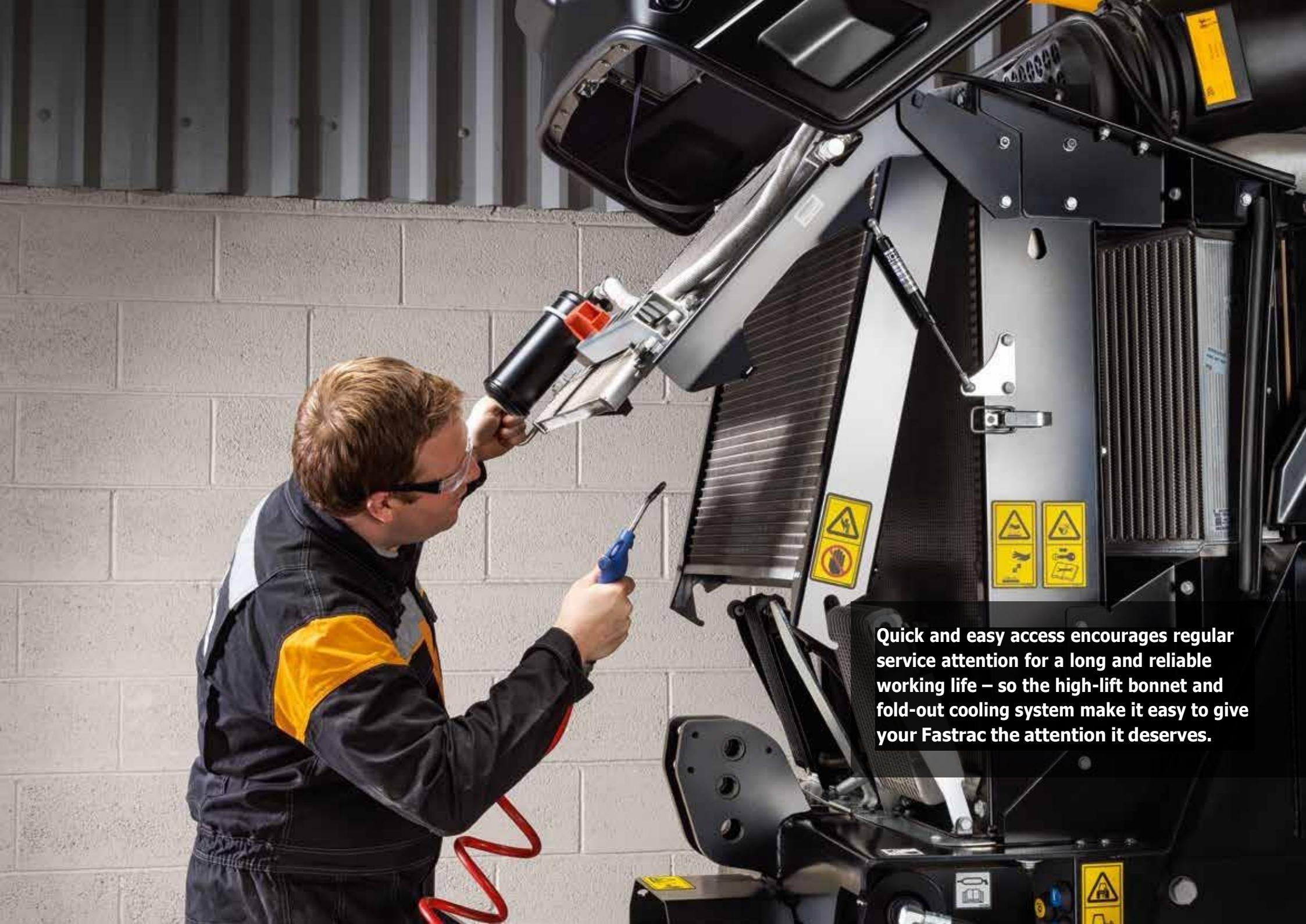

Quick and easy access encourages regular service attention for a long and reliable working life – so the high-lift bonnet and fold-out cooling system make it easy to give your Fastrac the attention it deserves.



LIVELINK TELEMATICS.

LiveLink telematics helps you monitor and manage your machine fleet remotely anywhere in the world by radically improving the efficiency, productivity, safety and security of all your JCB and non JCB machine fleet.

MACHINE EFFICIENCY: Keep track of your machine's daily activity with regular performance reports which provide information about idle time, location, machine health, error codes for diagnostics, engine utilisation by power band, safety alerts, and fuel consumption. JCB LiveLink ensures machines are kept running for maximum uptime and return on investment.

MACHINE RELIABILITY: Accurate hours and service alerts improve maintenance planning to optimise machine productivity.

MACHINE SECURITY: LiveLink's real time geo-fencing alerts tell you when machines move out of predetermined zones. Curfew alerts inform you of unauthorised usage.



Track the location of any asset via Bluetooth connection.



An after market telematics solution which can be retrofitted to any machine.



COMPLETE CONTROL FOR YOUR FLEET.

LiveLink Fleet enables you to track every aspect of your equipment to maximise efficiency and machine uptime.

GUESS LESS, KNOW MORE: Equipment issues and service reminders are logged as soon as they occur, helping you to react quickly.

YOUR EYES ON THE GROUND: Integrate LiveLink Fleet with the JCB Operator mobile app and data from your operators' daily equipment checks feed instantly into your dashboard.

TOTAL PEACE OF MIND: Operator safety alerts help to ensure machines are being used efficiently and safely.

SMARTER TOOLS. SMARTER DECISIONS: From hours worked to fuel wastage, access custom analytics on your fleet to make smarter decisions, quicker.

EFFORTLESS MEETS PAPERLESS: Access certificates, warranty information, quick start machine guides and manuals.

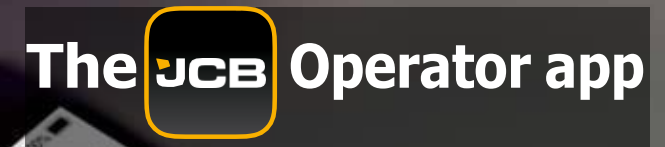

THEY SPOT IT, YOU KNOW IT.

The JCB Operator app gives you faster, clearer and more accurate information about your fleet, direct from the people using your equipment each day.

STAY IN TOUCH: Get regular checks on your machine with visibility in the LiveLink Fleet portal.

TAILOR YOUR CHECKS: Customise your checklists to suit any application, customer or site.

UPLOAD TO KEEP UPDATED: Upload useful information with photos and comments.

FULLY COMPATIBLE: The JCB Operator app works with non telemetry related machines and assets.

ACCESS ALL INFORMATION: Get access to documentation such as quick start guides.

*The individual features of LiveLink Telematics, LiveLink Fleet and Operator App vary per region, engine and machine type.

HERE TO MAKE THE DIFFERENCE.

JCB'S WORLDWIDE CUSTOMER SUPPORT IS FIRST CLASS. WHATEVER YOU NEED AND WHEREVER YOU ARE, WE'LL BE AVAILABLE QUICKLY AND EFFICIENTLY TO HELP MAKE SURE YOUR MACHINERY IS PERFORMING TO ITS FULL POTENTIAL.



1 Our Technical Support Service provides instant access to factory expertise, day or night, while our Finance and Insurance teams are always on hand to provide fast, flexible, competitive quotes.

2 The global network of JCB Parts Centres is another model of efficiency; with 18 regional bases, we can deliver around 95% of all parts anywhere in the world within 24 hours. Our genuine JCB parts are designed to work in perfect harmony with your machine for optimum performance and productivity.



3 JCB offers comprehensive extended warranties as well as service-only or repair and maintenance contracts. Irrespective of what you opt for, our Maintenance teams around the world charge competitive labour rates, and offer non-obligation quotations as well as fast, efficient insurance repair work.

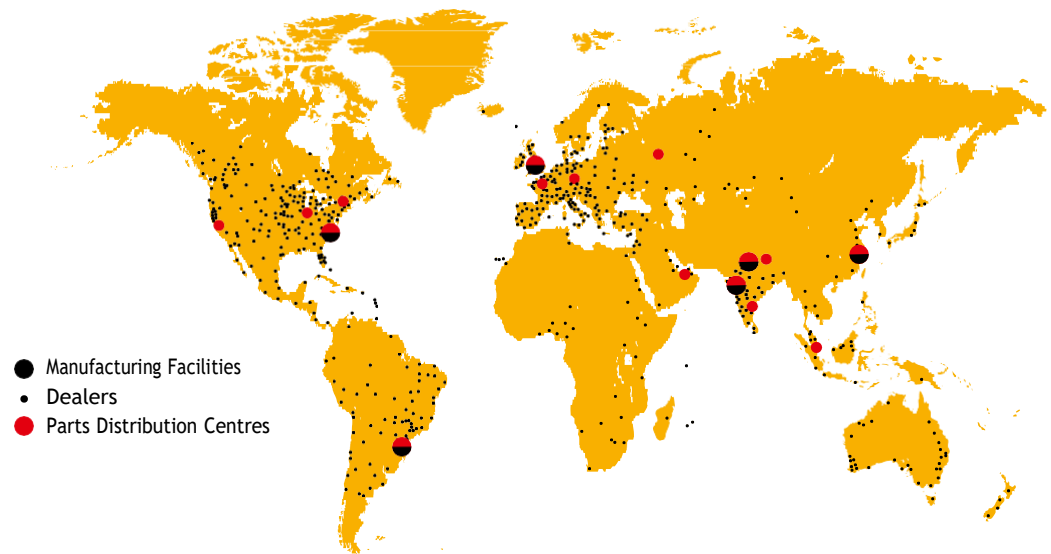

Note: JCB LIVELINK and JCB extended warranty packages may not be available in your region, so please check with your local dealer.

STATIC DIMENSIONS 8290, 8330

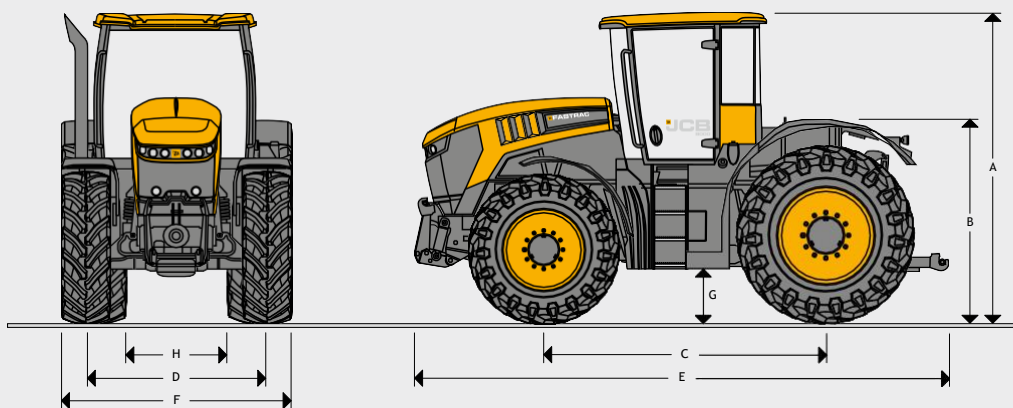

Tyres	540/65 R34 + 710/60 R42	
A Height over cab	m	3.45
B Height over deck	m	2.06
C Wheelbase	m	3.13
D Track width	m	2.03
E Overall length	m	5.65
F Overall width	m	2.55
G Ground clearance	m	0.60
H Width between tyres	m	1.1

ENGINE

Model	8290		8330	
Rated power 97/68 EC @ 2100rpm	hp (kW)	280 (209)	335 (250)	
Max. power 97/68 EC @ 1950rpm	hp (kW)	306 (228)	348 (260)	
Max. torque @ 1500rpm	Nm	1310	1440	
Make	AGCO Power			
Model	84 LFVC			
Injection	Bosch CP4 common rail			
No. of cylinders	6			
Capacity	cc	8419		
Bore	mm	111		
Stroke	mm	145		
Cooling	Water			
Air cleaner	Powercore dry element			
Aspiration	Turbocharged and intercooled			

SUSPENSION

Front & Rear: Hydro-pneumatic self leveling. 63mm double acting suspension (standard)

ELECTRICAL SYSTEM

System voltage	Volt	12
Alternator output	Amp	200
Battery capacity	Amp hour	2 x 110

CAPACITIES

Fuel tank	litres	600
Hydraulic tank	litres	150
Urea tank	litres	70

HYDRAULICS

Rear 3 point linkage control	Electronic raise/lower with depth, draft/position intermix, rate of drop and maximum lift height control plus external lift and lower.	
Rear 3 point linkage type	Category III; Quick attach hook ends, eye end top link.	
Rear 3 point linkage capacity	10000kg	
Front 3 point linkage (optional) control	Electronic raise/lower with depth, rate of drop and maximum lift height control plus external lift and lower	
Front 3 point linkage (optional) type	Category IIIN or II; Quick attach hook ends, folding arm.	
Front 3 point linkage (optional) capacity	3500kg	

AUXILIARY HYDRAULICS

Max. oil flow @ rated speed	l/min	178
Flow per slice	l/min	140
Operating pressure	bar	210
Spool valves	Electronic 7 position double acting with flow and time control, float position and zero leak	
Standard (Agricultural version)	4 spool valves to the rear	
Optional (Agricultural version)	5 spool valves to the rear, load sensing hydraulic connection, 1 or 2 front supplies, front free flow return	
Couplers	Quick release/spill-off piped to reservoir (front and rear)	

POWER TAKE OFF

Rear PTO type	Fully independent to front and rear (front optional)		
Actuation	Electro-hydraulic		
Rear PTO speeds	540rpm @1570 engine rpm, 1000rpm @ 1930 engine rpm		
Rear PTO output spline	21 spline 1" 3/8 diameter + 20 spline 1" 3/4 diameter		
Rear PTO type (optional)	6 spline 1 3/4" diameter (optional)		
Front PTO speed	1000rpm @ 2030 engine rpm (optional)		
Front PTO output spline	6 spline 1 3/8" diameter (optional)		
Model	8290	8330	
PTO power	hp (kW)	272 (203)	310 (231)

AXLES	
Type	Beam with outboard epicyclic reduction hubs.
Wheel mountings	10 stud front axle, 16 stud rear axle.
Four wheel drive engagement	Four wheel drive engagement Electrohydraulic.
Differentials	Differential lock: front and rear electro-hydraulics soft engage.

STEERING	
Type	Standard: Hydrostatic dual steering system, fixed ratio. Optional: Hydrostatic dual steering system, GPS ready with Rapid Steer.
Column	Tilt and telescope adjustable

BRAKES	
Type	Outboard discs with twin calipers and ABS on all four wheels.
Operation	Air over hydraulic to EEC truck specification.
Park brakes	Independent disc on transmission output
Actuation	Sprung on, air pressure off
Trailer brakes	Twin line air brakes, single line hydraulic brakes automatically applied by tractor park brake, ABS 12v trailer supply socket as standard

TRANSMISSION	
Type	2 range continuously variable transmission with 6 modes of operation.
Speeds (low)	0-40kph
Speeds (high)	0-70 kph

VEHICLE WEIGHTS					
		Front axle	Rear axle	Total	
Base machine less front linkage & FPTO	kg	5780	5610	11390	
+540/65 R38 front + 710/60 R42, front linkage & FPTO	kg	6030	5758	11788	
Maximum permissible mass	kg	9000	11500	18000	

WHEELS AND TYRES		
	Size	Track width standard mm (in)
Agricultural pattern	VF 540/65R38 + VF 710/60R42	2000 (78.7) + 2000 (78.7) / 2000 (78.7) + 1835 (72.2)
Agricultural pattern	VF 600/60R38 + VF 710/60R42	2000 (78.7) + 2000 (78.7)
Agricultural pattern	IF650/65R34 + 900/50R42	2208 (86.9) + 2040 (80.3)
Utility pattern	440/80R34 + 650/65R38	2109 (83.0) + 1905 (75.0)
Utility pattern	600/70R34 + 650/65R42	2000 (78.7) + 2000 (78.7)
Row Crop	VF 480/70R38 + VF 480/80R46	Variable Offset

Front directional and rear fixed fenders. All tyres are speed rated for 65kph or 70kph.

CAB	Standard equipment includes: Fully automatic climate control, Air suspension seat with armrest mounted transmission and auxiliary controls, Colour touch screen display, providing transmission information and setup capability, Electronic spool valves, Category 2 filtration, Front and rear wash wipe, Front and rear sunblind, Full road lighting equipment, Auxiliary electrical and speed sensor sockets, Full size passenger seat, Lap belt for driver and passenger, Slim line backlit dashboard, Storage compartment, Radio preparation with single DIN slot and four speakers. Cable access through rear window, Rear fender mounted raise/lower and PTO switches.
------------	---

OPTIONAL EQUIPMENT	Depending on model and territory: 850kg /1400kg front weight, 900kg / 900kg + 700kg rear deck weight, 6 spline 1 3/8" PTO shaft, 6 spline 1 3/4" PTO shaft, Headland Turn Assist with radar and performance monitor, Deluxe seating options, Heated front and rear screens, Electric heated mirrors with additional wide angle lens, Auxiliary audio input, Halogen and LED worklights options, External rear fender control buttons, 7 pin front power socket, 3 pin front power socket, Interior rear view mirror, Automatic rear linkage stabilisers, Hookend/hydraulic top link, Electric cool box, Rear hitch camera, Roof window.
---------------------------	--



ONE COMPANY, OVER 300 MACHINES.

Your nearest JCB dealer

AGRARTREND,s.r.o.

9999/6152 en-GB 02/20 Issue 1

Komárňanská cesta 10844

940 01 Nové Zámky

Mobil: +421 917 226 244

E-mail: pm@agrartrend.eu

Fastrac 8000 Series

Rated power: 209-250kW (280-335hp)

e ST14 5JP. Tel: +44 (0)1889 590312 Email:

salesinfo@jcb.com

Download the very latest information on this product range at: www.jcb.com

[facebook.com/JCBAg](https://www.facebook.com/JCBAg) [@JCBAgriculture](https://twitter.com/JCBAgriculture) [JCBAgriculture](https://www.instagram.com/JCBAgriculture) [youtube.com/JCBAgriculture](https://www.youtube.com/JCBAgriculture)

©2014 JCB Sales. All rights reserved. No part of this publication may be reproduced, stored in a retrieval system, or transmitted in any form or by any other means, electronic, mechanical, photocopying or otherwise, without prior permission from JCB Sales. All references in this publication to operating weights, sizes, capacities and other performance measurements are provided for guidance only and may vary dependant upon the exact specification of machine. They should not therefore be relied upon in relation to suitability for a particular application. Guidance and advice should always be sought from your JCB Dealer. JCB reserves the right to change specifications without notice. Illustrations and specifications shown may include optional equipment and accessories. All images are correct at time of print. The JCB logo is a registered trademark of J C Bamford Excavators Ltd.



J
C
B

A
g
r
i
c
u
l
t
u
r
e
,

R
o
c
e
s
t
e
r
,

S
t
a
f
f
o
r
d
s
h
i
r